

COMPLETE INSTRUCTIONS

# LEE RELOADER

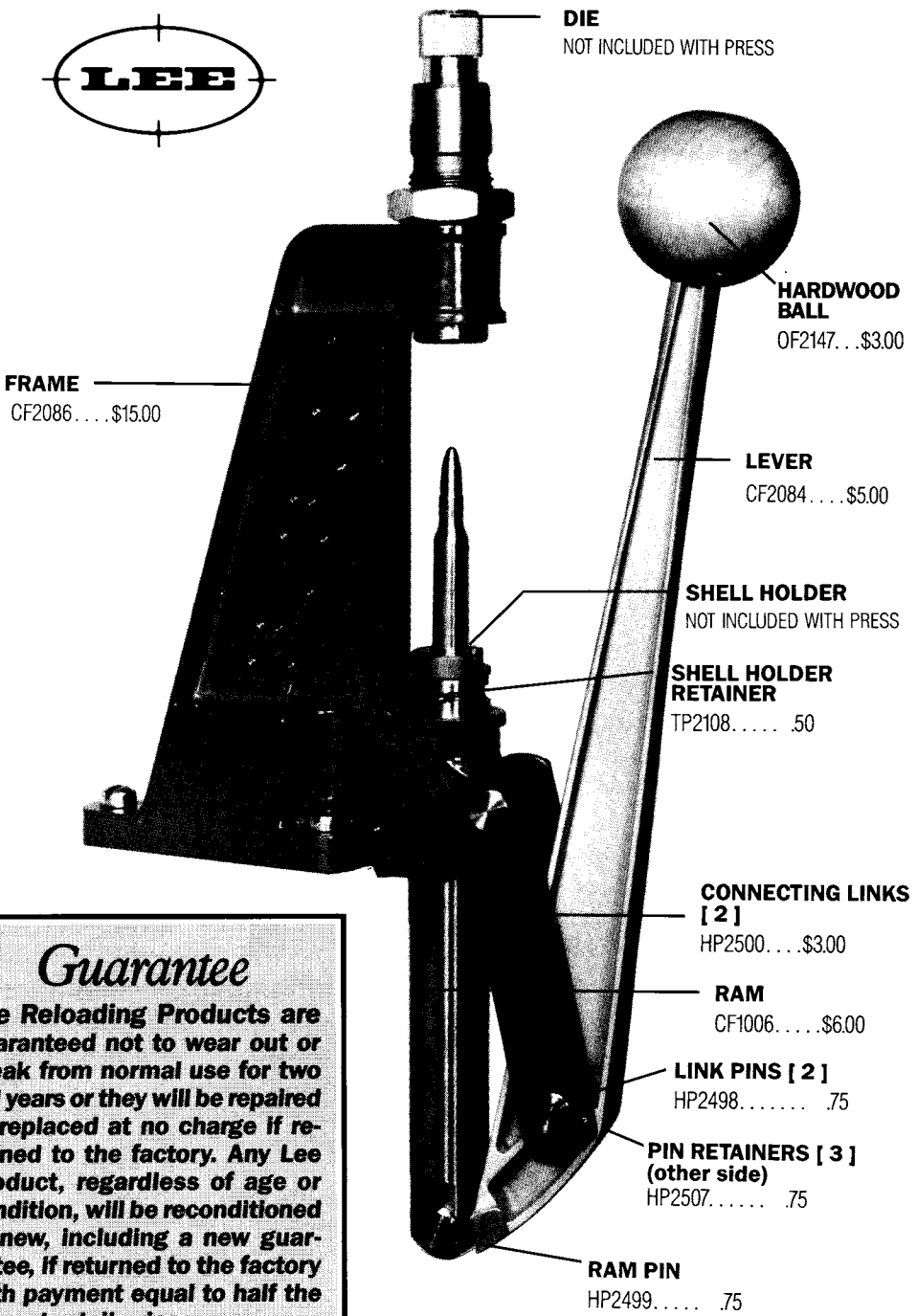

**DIE**  
NOT INCLUDED WITH PRESS

**HARDWOOD BALL**  
OF2147...\$3.00

**FRAME**  
CF2086...\$15.00

**LEVER**  
CF2084...\$5.00

**SHELL HOLDER**  
NOT INCLUDED WITH PRESS

**SHELL HOLDER RETAINER**  
TP2108..... .50

**CONNECTING LINKS [ 2 ]**  
HP2500...\$3.00

**RAM**  
CF1006...\$6.00

**LINK PINS [ 2 ]**  
HP2498..... .75

**PIN RETAINERS [ 3 ] (other side)**  
HP2507..... .75

**RAM PIN**  
HP2499..... .75

## Guarantee

Lee Reloading Products are guaranteed not to wear out or break from normal use for two full years or they will be repaired or replaced at no charge if returned to the factory. Any Lee Product, regardless of age or condition, will be reconditioned to new, including a new guarantee, if returned to the factory with payment equal to half the current retail price.

## CAUTION

Ammunition reloading can be dangerous if done improperly and should not be attempted by persons not willing and able to read and follow the instructions exactly. Children should not be permitted to reload ammunition without strict parental supervision. Ammunition loaded with these tools and data should only be used in modern guns in good condition. We do not accept responsibility for ammunition loaded with these tools or data as we have no control over the manufacture and storage of components or the loading procedure and techniques. Primers and gun powder, like gasoline and matches, can be dangerous if improperly handled.

# BEFORE YOU START RELOADING...

## LEE RELOADER PRESS

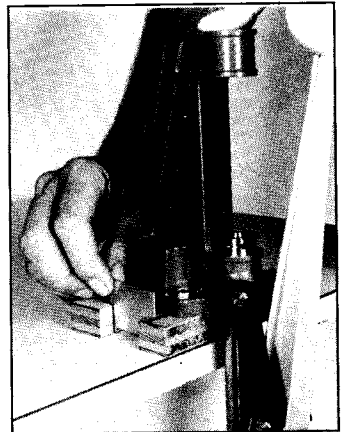
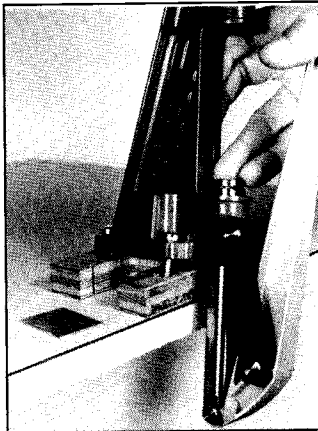
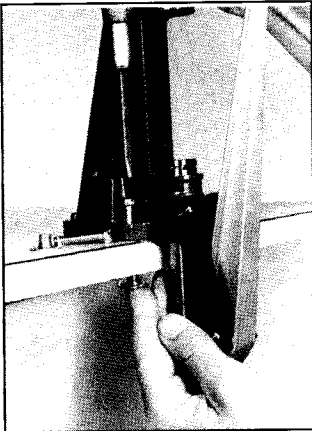

Attach your press with three (3)  $\frac{1}{4}$ " bolts. Use "T" nut for quick removal to empty the spent primers. **Note** You may drill a hole through the bench and catch the primers in a container below.

You can make your own easy-to-empty spent primer reservoir.

## RELOADING SAFETY

- ▶ Keep powder away from heat and open flames — don't smoke.
- ▶ Store powder and primers in their original containers in a cool, dry place.
- ▶ Read and follow instructions exactly.
- ▶ Be sure you have the correct powder, measure and bullet of the correct weight; any mixup can be dangerous.
- ▶ Exercise care and common sense at all times.
- ▶ Always wear safety glasses while reloading or shooting.

## RELOADING IS QUITE A SIMPLE PROCESS

- 1 Case is sized to original dimensions and the spent primer is removed.
- 2 Install a new primer.
- 3 Add a charge of powder.
- 4 Seat a new bullet and crimp if desired.



1. REMOVE SPENT PRIMER AND RESIZE CASE



2. INSTALL NEW PRIMER



3. ADD POWDER



4. SEAT A NEW BULLET

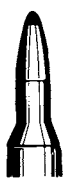

### CROSS SECTION OF A TYPICAL CARTRIDGE

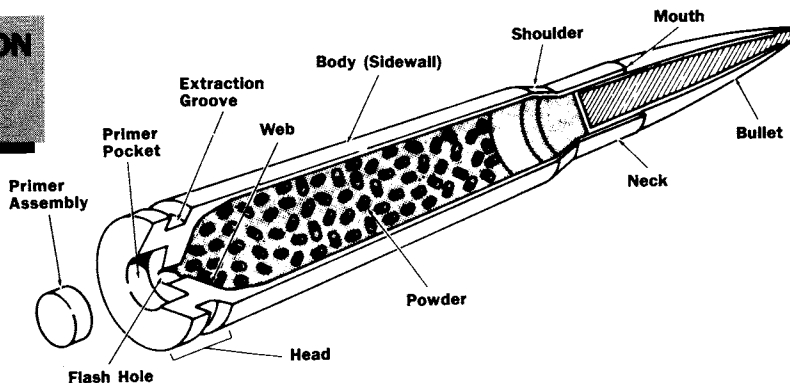

## **IT IS YOUR RESPONSIBILITY TO ENSURE THE SAFETY OF YOUR LOADS**

The following are factors that will increase pressures. Some will be dangerous.

- ▶ **Do not use more powder than recommended.**
  - ▶ **Do not use a heavier bullet than recommended.**
  - ▶ **Do not seat the bullet deeper than normal.**
  - ▶ **Do not use magnum primers unless using a slow burning ball powder.**
  - ▶ **Greatly over size bullets, excessively hard bullets or cases that are too long will cause higher pressures.**
  - ▶ **High temperatures, or cartridges that were stored in a hot car or car trunk will produce higher pressures.**
- 

### **CASES**

The easiest and best way of getting cases is to simply save those from your factory loaded rounds. New and used cases can also be purchased. Cases must be clean and safe. Do not use cases that have cracks or splits. If they have been used more than twice, they should be checked to see that none of them have become too long for safe use. The easiest way is to trim them with a LEE Case Trimmer. This automatically cuts them to the correct length and no gauging or measuring is needed. After trimming, be sure to chamfer both the inside and outside of the case. A LEE Chamfer Tool works best, but it can be done with a pocket knife.

Straight sided cases, such as those used by most handguns, are loaded with a 3-die set.

### **MILITARY CASES**

Used military cases are readily available at low cost. Usually, these have primers that are crimped in place. This is to prevent the primer from coming loose in automatic weapons and jamming the action at an inopportune time. The crimp must be removed before repriming. This can be done with a primer pocket reamer or swaging tool.

Even a LEE Chamfer Tool can be used to ream the crimp.

### **POWDER**

Powder is usually classified as smokeless and black powder. There is also Pyrodex, which is a substitute for black powder. We will be using only smokeless powder for reloading.

Each set of Lee Dies is supplied with a powder measure and charge table with a generous selection of loads. Additional load data is available from all the powder manufacturers and bullet makers. This is excellent information and should be followed exactly.

Different powders are available to do different jobs. Bullets having a high section density (long length in relation to their diameter) require a slow burning powder. This permits sustained peak pressure to gain maximum acceleration within working pressure limits.

Short, light bullets use quicker burning powder for complete combustion within the barrel. A wide selection of powder is readily available.

Powders should always be stored in their original containers. While smokeless powder is not an explosive and not as dangerous to handle as gasoline, it would be foolish to handle it carelessly and store excessive amounts. Follow the powder manufacturers' recommendations for storage and use.

### **PRIMERS**

Rifle and pistol cartridges require different primers. Rifle primers have a thick and stronger cup to withstand the higher pressure. Pistol primers have a thinner cup for easy detonation with a lighter hammer blow. Both rifle and pistol primers are available in large or small size. They are also available in regular and magnum. Use regular for all loads except if the load data specifies magnum primers.

Primers must always be stored in their original containers. It is always a wise idea to wear safety or shooting glasses when shooting or reloading.

### **BULLETS**

Commercial rifle bullets usually have a soft lead core with a copper jacket. Point shapes come in a variety of styles, but usually have some soft lead exposed to properly mushroom on impact.

The jackets serve a dual purpose: to control the bullet expansion and act as a bearing surface for its high speed travel down the bore. Some bullets have a crimping groove called a *cannelure*. This groove must be seated almost entirely in the case when crimping the case. The very end of the case mouth is turned into this groove by the bullet seating die. Crimping is a detriment to maximum accuracy and should not be done unless required as when used in a tubular magazine gun and most revolver ammunition.

Cast bullets are very popular with the handloader. These are very economical to use and for all guns where the velocity is less than 2000 feet per second and can be as accurate as jacketed bullets. They do not normally expand as well as soft lead jacketed bullets on game. Therefore, it is poor economy to use them for hunting.

# YOU CAN NOW BEGIN RELOADING

**CAUTION: WEAR SAFETY GLASSES**

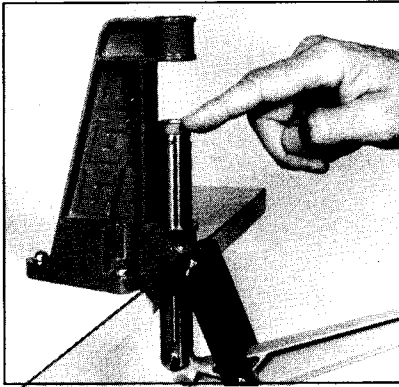

## 1 INSTALL SHELL HOLDER

**2 INSTALL SIZING DIE.** While holding the handle against the stop, screw the die in until it touches the shell holder, then release pressure from the handle and screw the die in an additional  $\frac{1}{4}$  to  $\frac{1}{2}$  of a turn maximum. Now, while holding the die, tighten the lock ring.

**NOTE:** Carbide dies should not be screwed in the additional  $\frac{1}{4}$  turn.

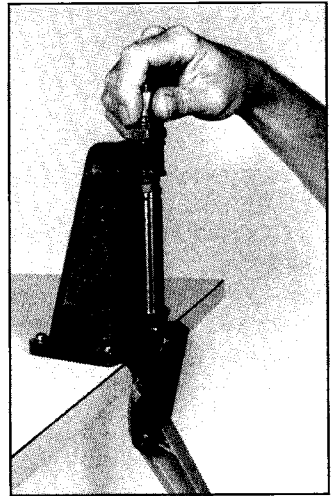

**3 PREPARE YOUR CASES.** Inspect your cases while lubricating them. Discard all cases with split necks, indications of head separation, or other defects. Wipe on a thin film of Lee Case Lubricant with your fingers. Fingers are the best way of lubing a case as any grit that could damage the die is wiped away. With Lee dies, you can lube the entire case including the neck and shoulder. The case may be immediately sized or you can let the lube dry.

Be sure to lube the inside of the case neck with a cotton swab.

## CAUTION

If for any reason you do not use Lee Resizing Lubricant, be very careful not to contaminate the powder or primers. All other brands are oil base and they have serious, detrimental effects on powder and primers. Because of the stickiness, they also attract grit that can damage the die. Lee Resizing Lubricant costs less and is so superior that it is worth the effort to insist upon it or order direct from the factory.

Carbide dies need no lubrication.

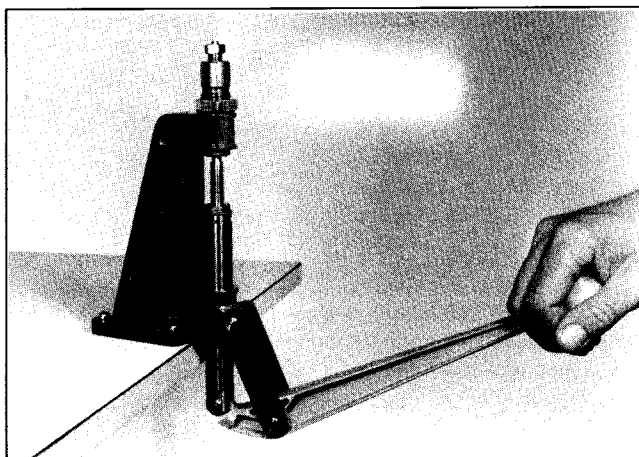

**4 PLACE THE LUBRICATED CASE** in the shell holder and raise the ram until the handle comes to a stop. Lower the ram and remove case.



**RAM PRIME** safe with all brands of primers.



**AUTO PRIME II** fits in your press and uses the same shell holder used for reloading. Safe only with CCI or Winchester brand primers.

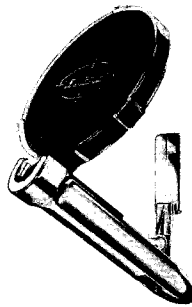

**AUTO PRIME** is hand held and requires special, but inexpensive shell holders. Safe only with CCI or Winchester brand primers.

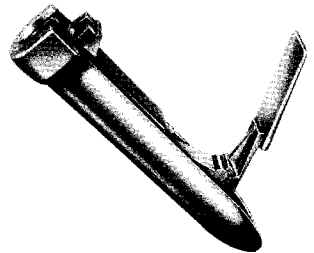

**IMPROVED PRIMING TOOL** safe with all brands of primers.

**5 PRIME YOUR CASE** with one of the optional priming tools. Follow the instructions included with the tool.

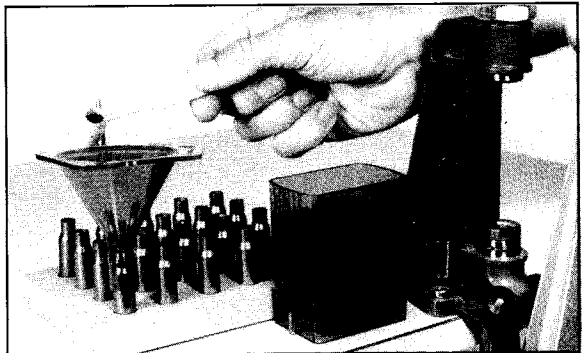
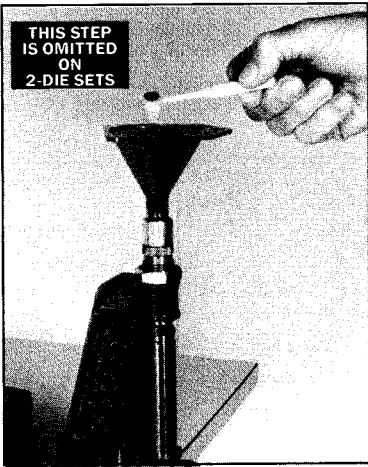

**6 THE CASE MOUTH** must be flared for ease of bullet installation. Raise the ram to expand the case neck. To increase the flare, screw the die in deeper. Always adjust to provide minimum flare needed to start the bullet. After proper adjustment, tighten the lock ring. Powder may be added through Lee Expanding Die.

**7 CHARGE THE CASE.** Regardless of how you charge the case, be absolutely certain you have the correct amount and type of powder for the bullet you have selected.

**NEVER try to seat the primer deeper after the powder has been added.**

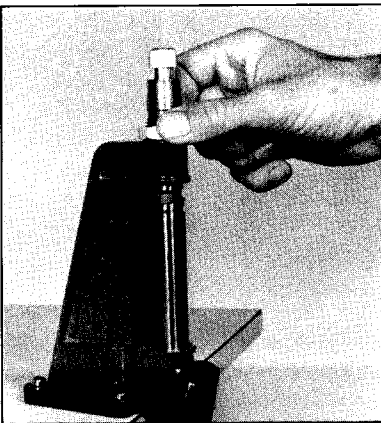

**9 SEAT THE BULLET:** Place a bullet on the case mouth and guide it into the die. Raise the ram to the top and withdraw. The knurled adjusting screw controls the bullet seating depth. Adjust to suit. Usually, seating to the same depth as a factory round works fine. If you desire to crimp, be sure the bullet crimp groove is almost completely inside the case. Then screw the die in just enough to apply a good crimp. Attempts to apply excessive crimp will crush the case. For proper crimp, all cases must be trimmed to the same length. Do not attempt to crimp if there is no crimp groove in the bullet.

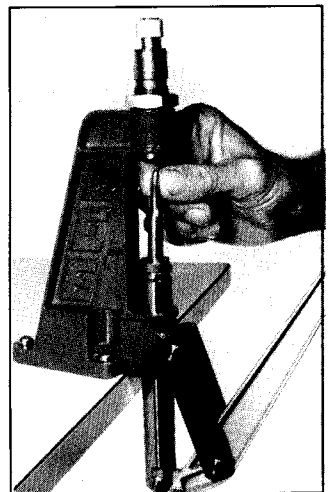

**8 INSTALL BULLET SEATING DIE:** Screw the bullet seating die in until you feel it touch the case mouth. If no crimp is desired, back the die out 1/2 turn. If a crimp is desired, turn the die in 1/4 turn. The bullet must have a crimping groove or it cannot be crimped.

**10 IF LOADING** maximum loads, it is a good practice to remove all traces of case lubricant with detergent and water. This will reduce pressure against the bolt.

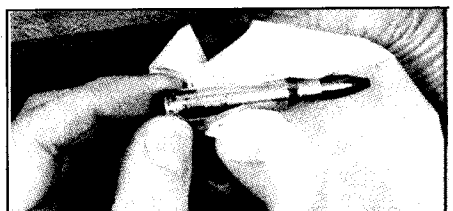

## Lee Primer Pocket Cleaner ►

Enhances accuracy and assures full depth primer seating.

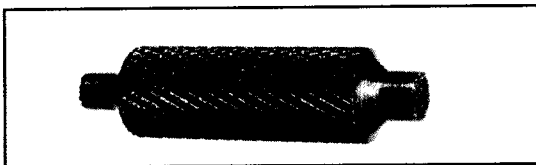

## Lee Case Trimmer ►

The simplest and safest way to check the case and trim to the correct length. No numbers to look up, and no expensive calipers required.

**After a few loadings, cases tend to get longer. This could be dangerous if the case were so long that it would pinch the bullet in the end of the chamber. Pressure high enough to damage the gun could result.**

Notice how the case length gauge passes through the case and stops against the lock stud and trims every case to the correct length.

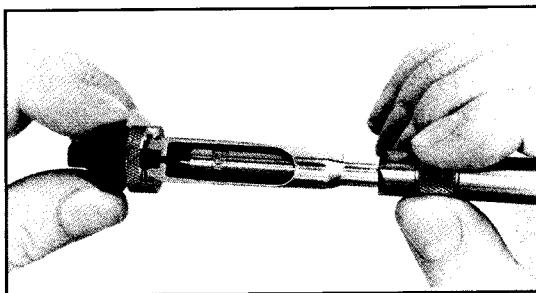

► After trimming, chamfer the inside and outside of the case mouth with the **Lee Chamfer Tool**.

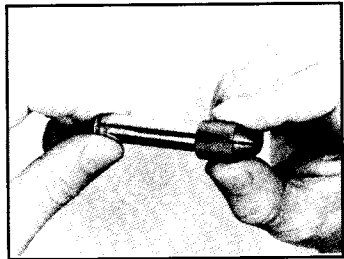
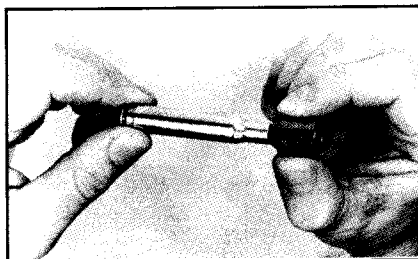

# LEE SAFETY POWDER SCALE

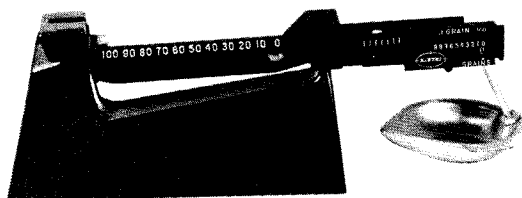

It is the easiest to use, most accurate and sensitive powder scale made exclusively to weigh gun powder.

The Lee Safety Scale has magnetic dampening and an approach to weight lifter enclosed within its heavy metal base. The exclusive safety beam has a stainless steel razor edge for maximum sensitivity. You can be sure that the Lee Safety Scale will retain its original factory accuracy for as long as it is not physically broken. Order one in a color to match your equipment.

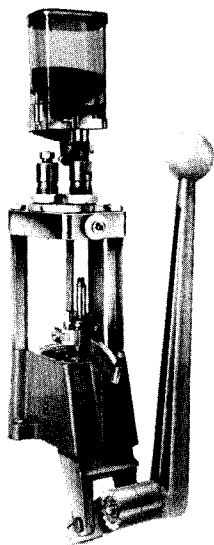

## LEE TURRET PRESS

A strong and powerful tool with features not found on any other tool regardless of the price. Compound linkage full length sizes the largest magnum cases with ease. Completely reversible for left-hand use. Built-in primer catcher. Snap out turret. Primer arm lifts out for large or small size. Makes all other reloading presses obsolete. For the ultimate in convenience and speed, move up to the Lee Turret Press.



**LEE PRECISION, INC.**